

Trim Length: - Per customers specification
Weight per lineal ft.: - Soleo 6008 = 0.5 lbs

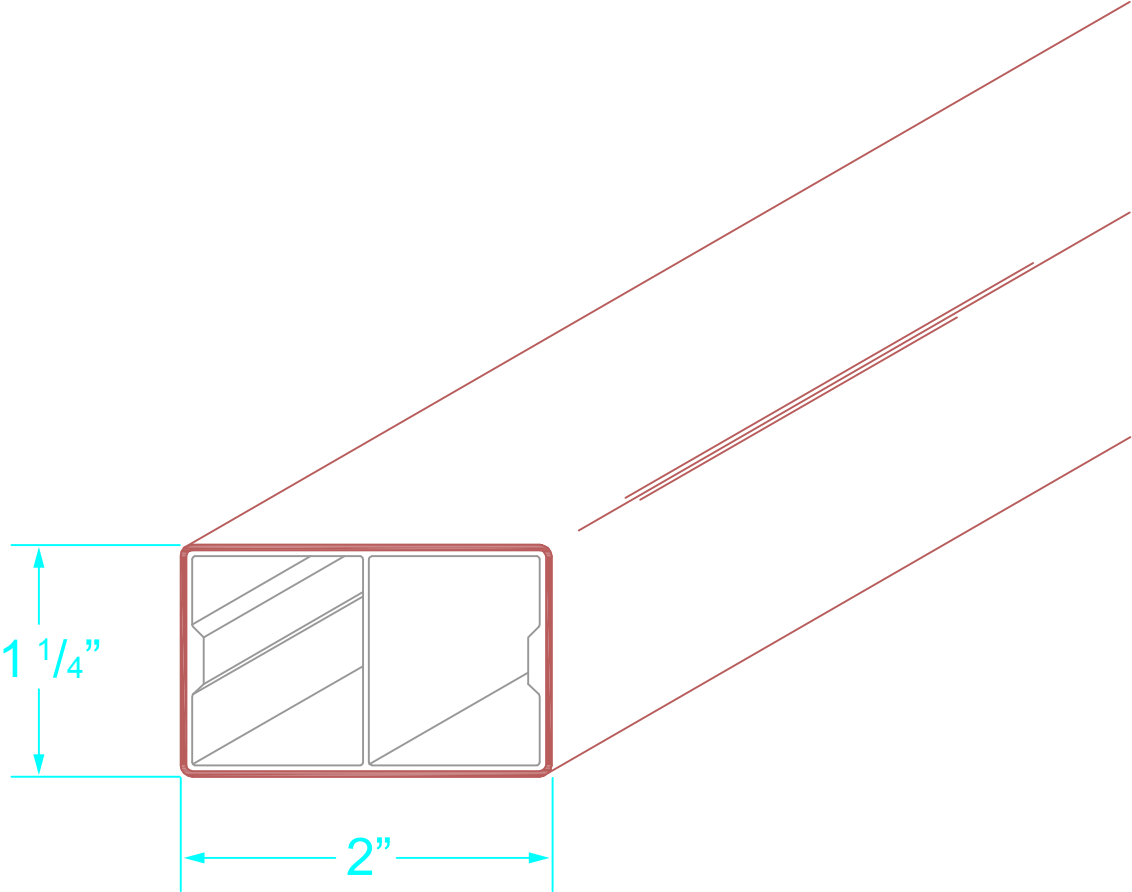

Soleo 6008

Geolam
Architectural Eco-Technology

Title
**Hybrid Aluminum/WPC
Soleo 6008**

Drawn **BR** Revision **A**

Date **2/22/16** Date **3/21/17**