

Trim Length: - Per customers specification  
Weight per lineal ft.: - Soleo 6012 = 0.9 lbs

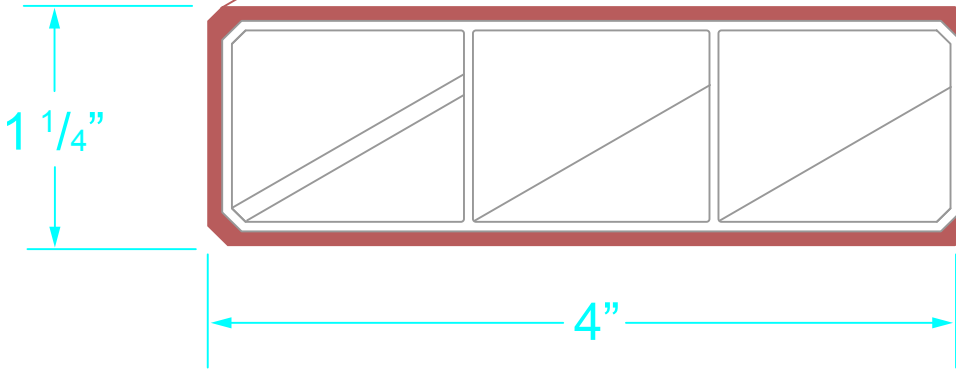

Soleo 6012

**Geolam**  
Architectural Eco-Technology

Title  
**Hybrid Aluminum/WPC  
Soleo 6012**

Drawn **BR** Revision **A**

Date **3/10/17** Date **3/21/17**